

hvacel 

*IGK
Heat Recovery Unit*

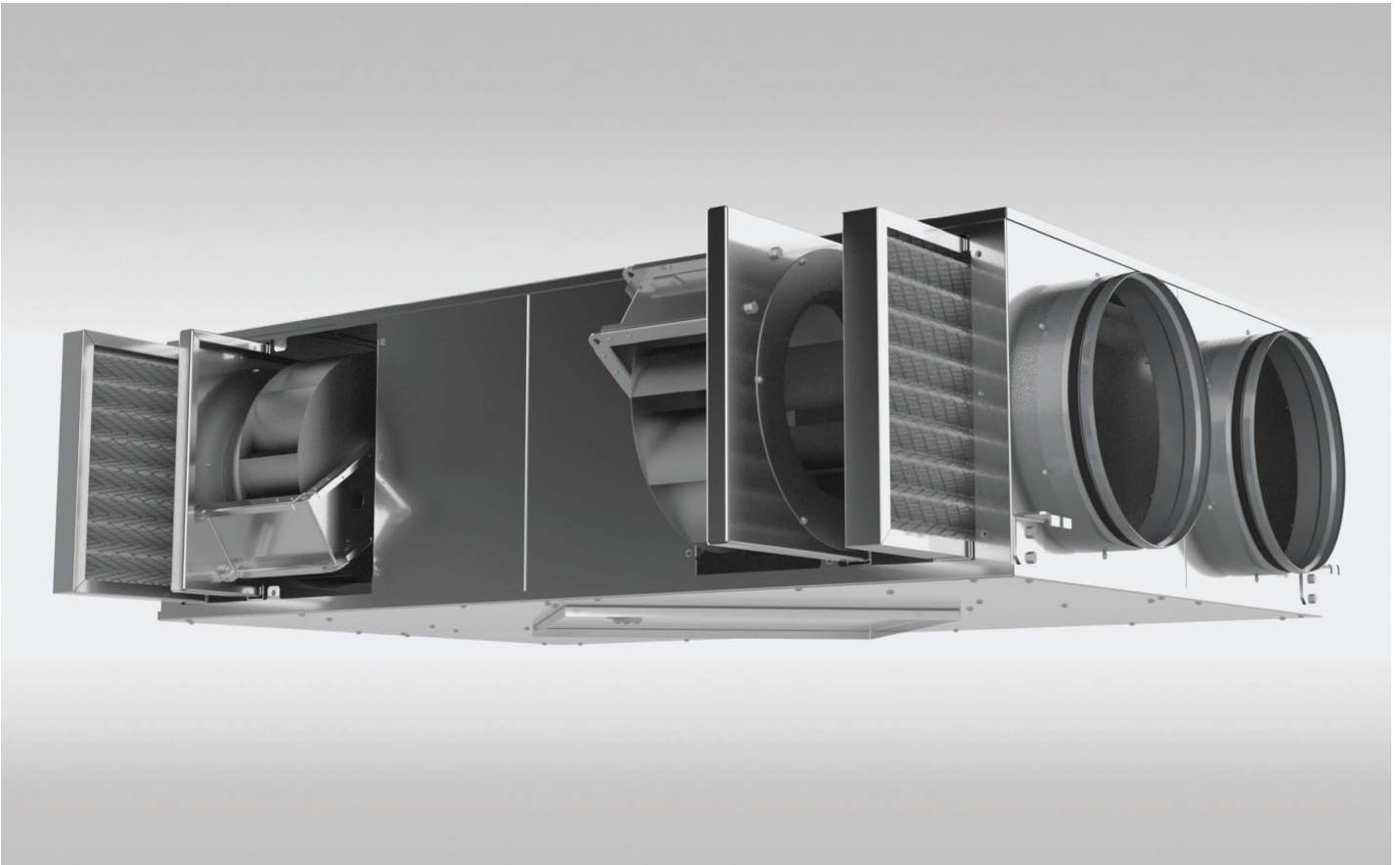

General Features



Quiet & Efficient

- *For lower energy consumption, high efficient backward curved radial fans.*
- *High thermal efficient aluminum plate recuperators,*
- *Low noise level,*
- *High static pressure,*
- *G4 filter,*
- *Stepless speed control,*
- *Electric heater, DX heat exchanger, water coils can be integrated.*
- *Optional duct type circular attenuator for easy installation*
- *Optional intelligent automation solutions*
- *Efficiency %50 to %70**

**depends on circumstances*

Working System

Low-quality indoor air is produced in areas that are air-conditioned by heating or cooling, where carbon dioxide and other harmful gases are concentrated.

While this air is being exhausted, the heat load it carries is collected in the plate recuperator of the IGK - Heat Recovery Unit and the in-take fresh air is conditioned.

Thus, it is possible to recover the heat load in this air by 50-60% while the poor indoor air is discharged.

IGK— Heat Recovery Units are quiet and high efficient with plug fan motors on them.

The device can be operated at the desired flow rate with the speed controller sent as standard.

Material

IGK-Heat Recovery Unit consists of 6 main parts.

-Case (1) is made of galvanized steel. 9mm rubber insulation and sound and heat insulation is provided.

-Fresh air and exhaust fans are radial fans with backward curved blades (2) For blade material Aluminum, Galvanized or Plastic can be selected.

-Service Covers (3) are located on the casing to easily carry out the maintenance with the fans and filters. By means of these covers, the fans can be easily removed in case of maintenance or failure.

-G4 filter (4) is available in both exhaust and fresh air inlets of the device.

-In this way, the main equipment of the device, Aluminum Plate Recuperator (5) is kept clean and working efficiently.

-In order to make the cable connection of the device easily, the Electrical Connection Box (6), which has the terminal connections of the fans, is fixed on the case.

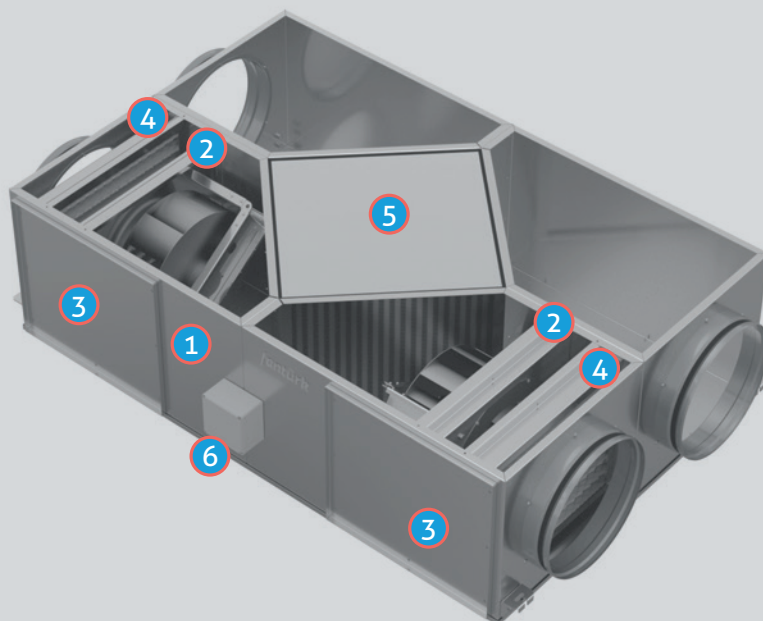

Device Equipments

PLUG FAN

- Backward Curved Blades
- High efficiency
- Low power consumption
- Low noise level
- High static pressure
- Thermo protection element against overheating of the motor
- Easy to remove and service thanks to the service cover.



HEAT RECOVERY RECUPERATOR

- Long life aluminum plate type recuperator
- High sensible heat transfer efficiency
- Sound damping feature
- Easy to remove and service thanks to service cover
- Washability
- Eurovent certificate

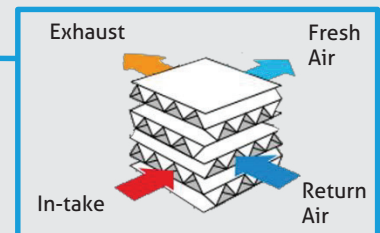
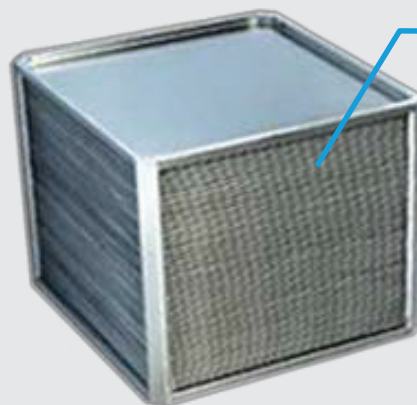

SPEED SWITCH

- Glass Safety Fuse
- Electronic Potentiometer
- Infinite speed adjustment between minimum and maximum voltage range



Control Panel

- Automatic or Manual program selection
- Easy to use with ready-made scenarios
- Possibility to integrate with electric heater, DX battery, water coils systems
- Possibility to use Modbus system
- Fresh air and exhaust fan speed adjustment
- Additional heating equipment adjustment
- Ventilation under continuous comfort conditions with integrated room thermostat

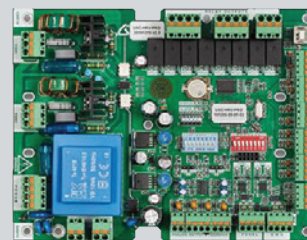

Available Functions

- Single Motor Speed Fan Proportional Speed Control
- Fan Speed Control with Three Motor Speed *
- EC Fan Control (0-10V) *
- Electric Heater Control
- Preheater Control *
- Air Quality and CO2 Control
- Proportional Heating / Cooling Control *
- On / Off Heating / Cooling Control
- By-Pass Damper Control *
- DX Battery Frost Protection *
- Recuperator Freezing Control
- Compressor Control *
- Filter Pollution Control
- Remote Control
- Weekly Calendar
- Modbus RTU Communication *
- BACnet MS / TP Communication *

* Marked functions required must be specified separately when ordering.

External Sensor Connections

- Return Air Sensor
- Supply Air Sensor
- Fresh Air Sensor
- Exhaust Air Sensor
- Air Quality Sensor
- CO2 Sensor
- Humidity Sensor *

Technical Specifications

HEAT RECOVERY UNIT

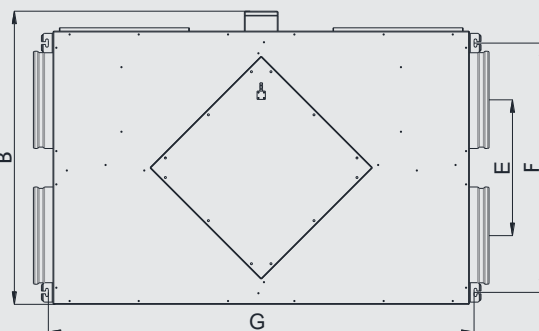
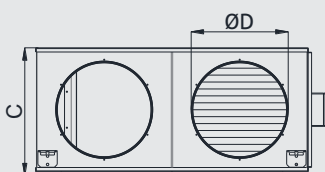
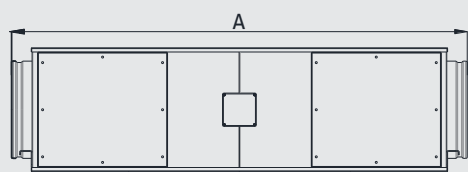

MODEL	A	B	C	ØD	E	F	G	FLOW RATE	VOLTAGE	FREQUENCY	MOTOR POWER	CURRENT	CAPACITOR	MOTOR SPEED	SOUND PRESSURE LEVEL	WEIGHT
	mm	mm	mm	mm	mm	mm	mm	m ³ /h	V	Hz	W	A	µf	rpm	dBA	Kg
IGK 500	980	680	320	200	300	520	880	500	230	50	2x66	2x0,3	2x3	2300	42	35
IGK 750	1085	730	370	200	325	575	985	750	230	50	2x100	2x0,47	2x3	2580	44	45
IGK 1000	1270	800	370	250	360	640	1170	1000	230	50	2x150	2x0,7	2x4	2600	47	55
IGK 1500	1270	880	400	250	400	720	1170	1500	230	50	2x200	2x0,9	2x6	2600	48	60
IGK 2000	1380	1060	460	276	490	900	1280	2000	230	50	2x250	2x1,1	2x8	2500	48	105
IGK 3000	1650	1060	460	350	490	900	1540	2500	230	50	2x210	2x1	2x8	1400	49	130
IGK 4000	2050	1310	630	400	615	1150	1950	4000	230	50	2x500	2x1,8	2x12	1380	52	165
IGK 5000	2090	1370	690	450	645	1210	1990	5000	230	50	2x500	2x2,2	2x12	1300	53	210
IGK 6500	2090	1370	690	500	645	1210	1990	6500	230 380	50	2x1560	2x6,8	2x31	1330	53	210

Duct Type Electric Heater

- TSEK Quality Certificate and CE mark.
- Used in the outlet of heat recovery unit in cold climates and in fresh air in-take against freezing in very cold climates.
- Can be designed single, double or triple step according to customer needs.
- Can be produced as galvanized or stainless steel body according to the project requirements.
- It has limit overtemperature circuit to be activated at 70 ° C and reset overtemperature circuit to be activated at 110 ° C.

MODEL	IGK 500	IGK 750	IGK 1000	IGK 1500	IGK 2000	IGK 3000	IGK 4000	IGK 5000	IGK 6500
ØD	Ø200	Ø200	Ø250	Ø250	Ø280	Ø355	Ø400	Ø450	Ø500
Capacity	1 Kw	2 Kw	3 Kw	3 Kw	5 Kw	7 Kw	10 Kw	13 Kw	15 Kw

Motor Power Range of Round Duct Type Electric Heater

Min. 0,5 kW – Max. 15 kW

Dimensions of Round Duct Type Electric Heater

Ød: Min. 100 mm / Max. 500 mm

L: Standart 380 mm / Max. 500 mm

A: Min. 275 mm / Max. 395 mm

B: Standart 200 mm

C: Standart 75 mm / 220 mm (If control equipment available)

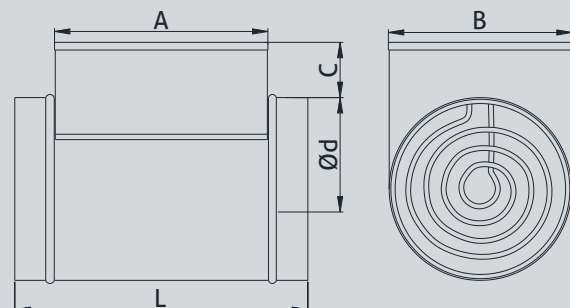

Performance Curves

IGK 500

Flow Rate 500 m³/h
Voltage 230 V
Frequency 50 Hz
Motor Power 2x66 W
Current 2x0,3 A
Capacitor 2x3 µf
Motor Speed 2300 rpm
Sound Pressure Level 42 dBA
Weight 35 kg
Electric Heater 1 kW-1 Stg.

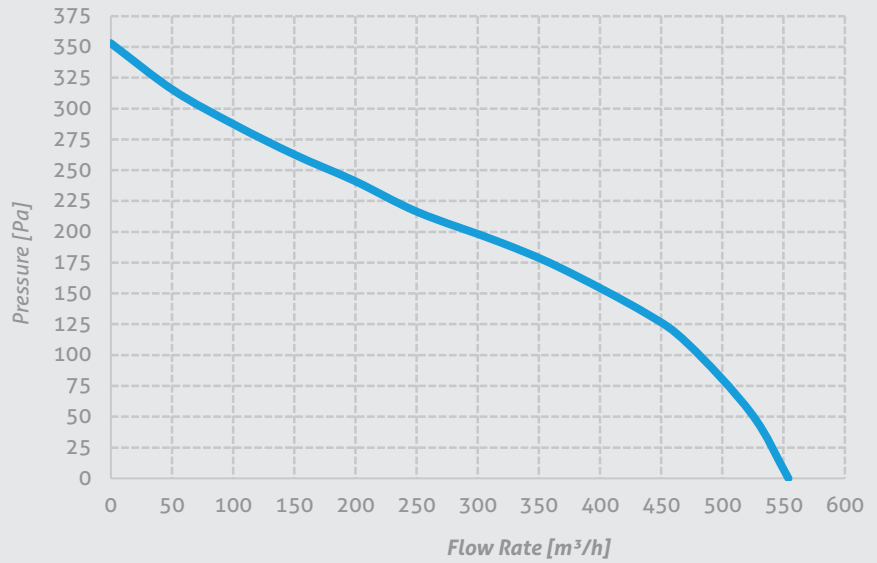

IGK 750

Flow Rate 750 m³/h
Voltage 230 V
Frequency 50 Hz
Motor Power 2x100 W
Current 2x0,47 A
Capacitor 2x3 µf
Motor Speed 2580 rpm
Sound Pressure Level 44 dBA
Weight 45 kg
Electric Heater 2 kW-1 Stg.

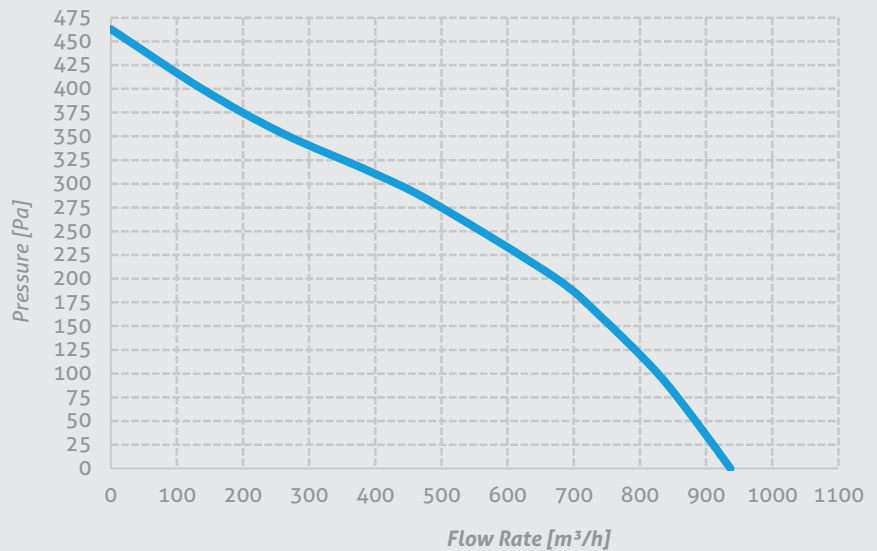

IGK 1000

Flow Rate 1000 m³/h
Voltage 230 V
Frequency 50 Hz
Motor Power 2x150 W
Current 2x0,7 A
Capacitor 2x4 µf
Motor Speed 2600 rpm
Sound Pressure Level 47 dBA
Weight 55 kg
Electric Heater 3 kW-1 Stg.

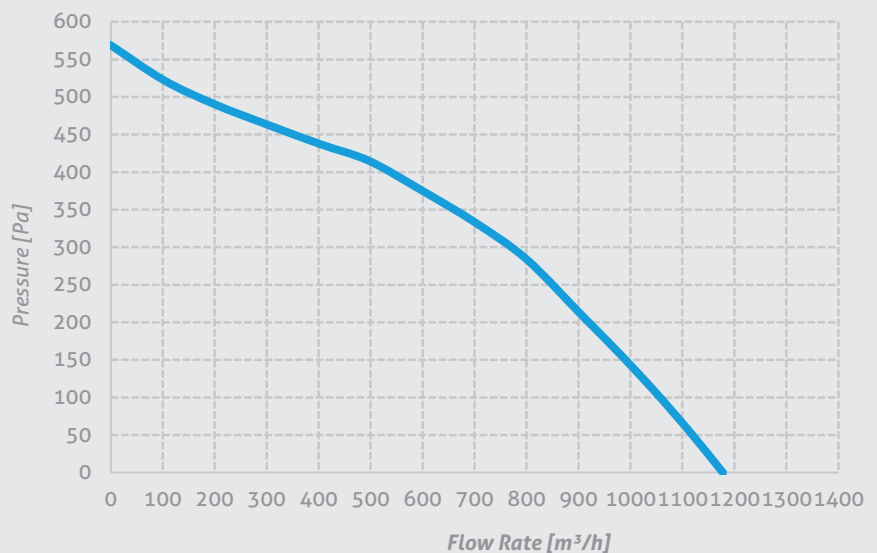

Performance Curves

IGK 1500

Flow Rate 1500 m³/h
Voltage 230 V
Frequency 50 Hz
Motor Power 2x200 W
Current 2x0,9 A
Capacitor 2x6 µf
Motor Speed 2600 rpm
Sound Pressure Level 48 dBA
Weight 60 kg
Electric Heater 3 kW-1 Stg.

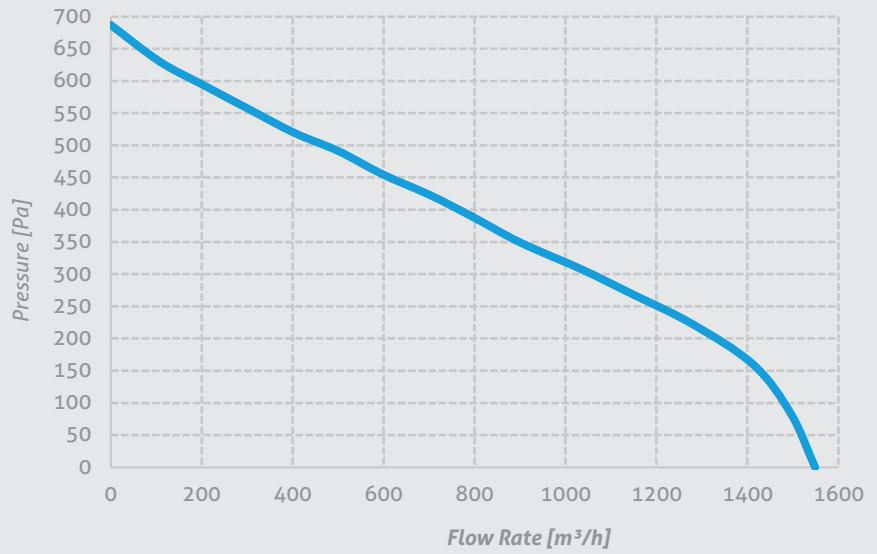

IGK 2000

Flow Rate 2000 m³/h
Voltage 230 V
Frequency 50 Hz
Motor Power 2x250 W
Current 2x1,1 A
Capacitor 2x8 µf
Motor Speed 2500 rpm
Sound Pressure Level 48 dBA
Weight 105 kg
Electric Heater 5 kW-1 Stg.

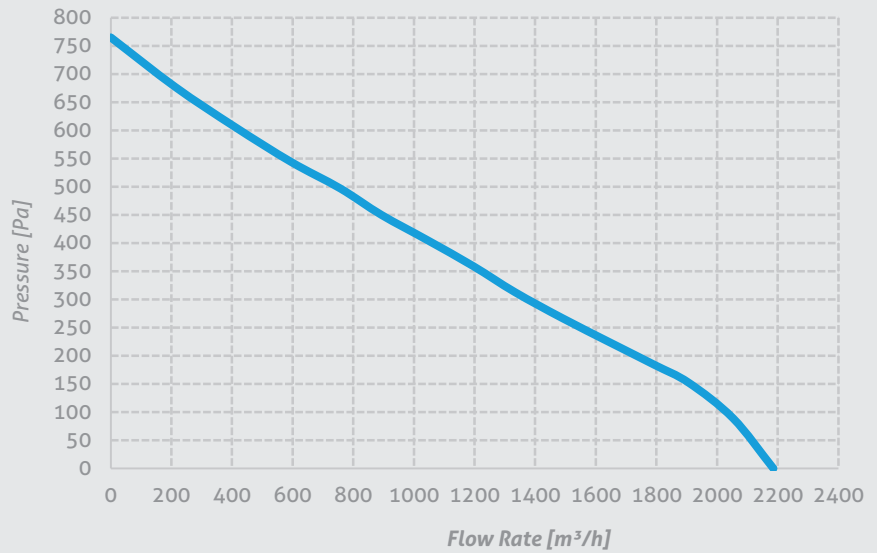

IGK 3000

Flow Rate 2500 m³/h
Voltage 230 V
Frequency 50 Hz
Motor Power 2x210 W
Current 2x1 A
Capacitor 2x8 µf
Motor Speed 1400 rpm
Sound Pressure Level 49 dBA
Weight 130 kg
Electric Heater 7 kW-1 Stg.

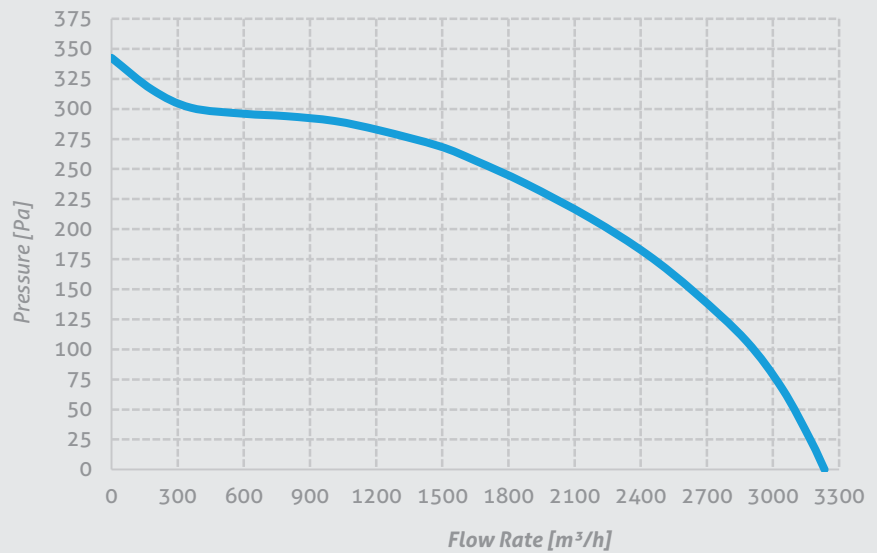

Performance Curves

IGK 4000

Flow Rate 4000 m³/h
Voltage 230 V
Frequency 50 Hz
Motor Power 2x500 W
Current 2x1,8 A
Capacitor 2x12 µf
Motor Speed 1380 rpm
Sound Pressure Level 52 dBA
Weight 165 kg
Electric Heater 10 kW-1 Stg.

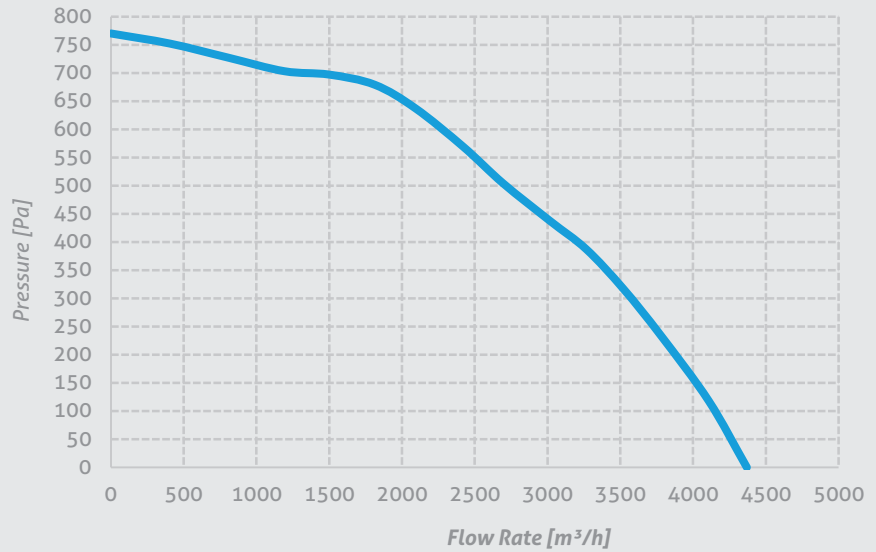

IGK 5000

Flow Rate 5000 m³/h
Voltage 230 V
Frequency 50 Hz
Motor Power 2x500 W
Current 2x2,2 A
Capacitor 2x12 µf
Motor Speed 1300 rpm
Sound Pressure Level 53 dBA
Weight 210 kg
Electric Heater 13 kW-1 Stg.

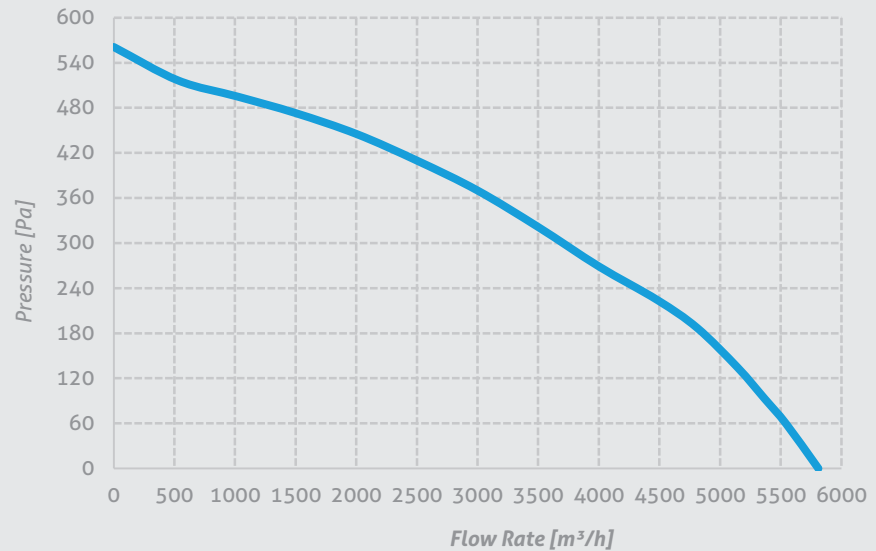

IGK 6500

Flow Rate 6500 m³/h
Voltage 230 V / 380 V
Frequency 50 Hz
Motor Power 2x1560 W
Current 2x6,8 A
Capacitor 2x31 µf
Motor Speed 1330 rpm
Sound Pressure Level 53 dBA
Weight 210 kg
Electric Heater 15 kW-1 Stg.

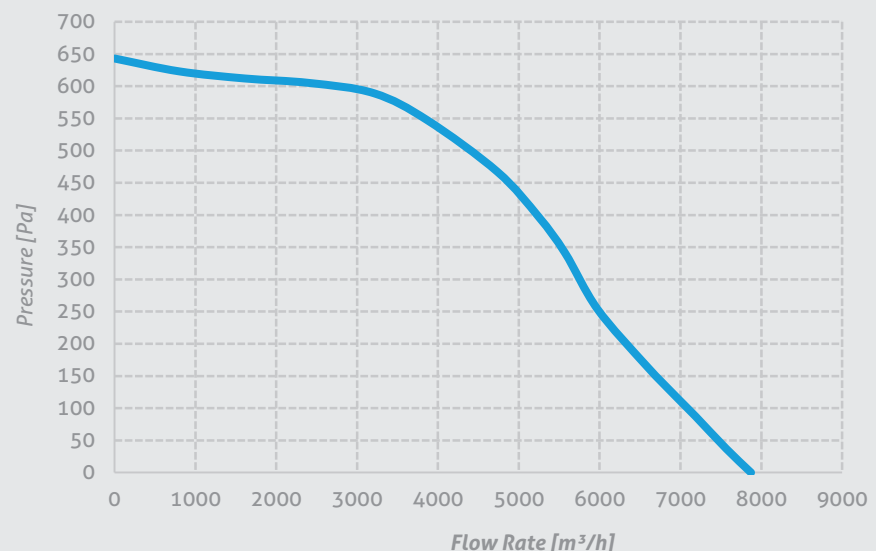



Contact Information:

*Address: Minareliçavuş OSB Mah. 202. Sk. N:19 Nilüfer /
BURSA / TURKEY*

Export & International Operations Manager:

Mr. Aslan TEKİN

Mobile: +90 552 616 40 57 (WhatsApp, Viber, Telegram)

Group Mail: export@hvacel..com

